

Temperature & Pressure Recorders

Model RPO / RTO

Data sheet : RPO-RTO/2012

- 1, 2 & 3 pen pressure recording and controlling at low cost
- Uses proven and reliable Rototherm pressure systems
- Simple installation and maintenance requirement
- Portable stand or pipe mounting available
- Fully mechanical versions available
- Electrical, battery or mechanical chart drive options

Introduction

The RPO range of pressure circular chart recorders uses the well proven and reliable Rototherm stainless pressure system.

These reliable and accurate instruments are suitable for most applications where there is a requirement for low cost pressure recording.

Pens

Fitted to the pen arms are disposable fibre tipped pens which are readily replaced without mess. The first pen of the two and three pen recorders trace in red ink, the second pen in blue, the third in green.

Specifications

ACCURACY

+/-1% FSD

AMBIENT TEMPERATURE

-20°C to +50°C

CHART DRIVE

Synchronous electric, battery or mechanical spring wound. 24 hour or 7 day. (other rotations on request)

CHARTS

Disc 240mm (9.5 inches) diameter. Standard dividing 40, 50, 60, 70 or 80 linear divisions.

INKING SYSTEM

Disposable fibre tipped pens.

2 pen : red & blue 3 pen : red, blue and green

CASE

Glass filled polyester resin. protection rated to IP55

WINDOW

Acrylic

POWER SUPPLY

200 to 250 volts, 50Hz (60Hz available); 100 to 110 volts, 50Hz (60Hz available);

Instruments without electrical control require no power supply provided that a clockwork chart drive is fitted. Battery operated chart drives require 1.5 volt type "C" cell.

MOUNTING

Suitable for surface or panel mounting. (Pipe mounting and portable options available)

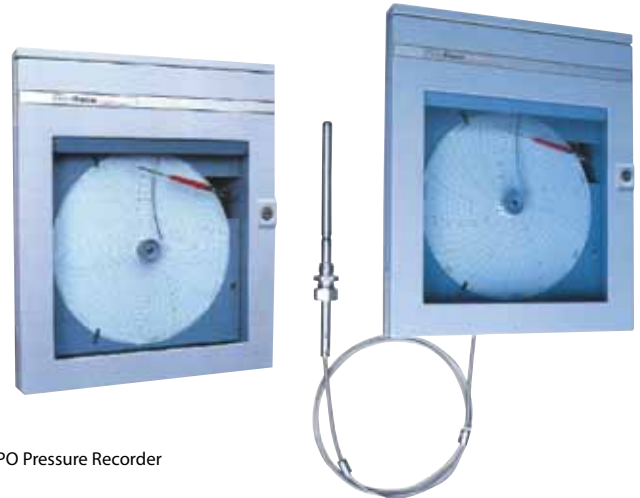

RPO Pressure Recorder

RTO Temperature Recorder

WEIGHT

Single pen : 6.5 kg (14.25lb)

Two pen : 7.0 kg (15.5lb)

Three pen : 7.5 kg (16.75lb)

Portable single pen : 8.6 kg (19 lb)

RPO Pressure Recorders

PRESSURE MEASURING ELEMENT

Stainless steel or Non Ferrous Bourdon tube or pressure capsule

PRESSURE CONNECTION

Standard 3/8" BSP male, with nut and tail pipe suitable for 6.35mm (1/4") outside diameter tube.

Portable 3/8" BSP male, with nut and tail pipe suitable for 6.35mm (1/4") outside diameter tube or 3/8" inside diameter tube.

Receiver Type 1/4" BSP female (input 3-15 psi 0.2-1 Bar)

RTO Temperature Recorders

MEASURING ELEMENT

Rototherm thermal bourdon tube temperature compensated.

CAPILLARY

Microbore stainless steel tube with 3mm diameter stainless steel cover (type C1) as standard. Other capillary types are available.

BULB AND STEM

Stainless steel BS970 316. Standard diameter is 12.7mm.

FITTINGS

Compression gland (adjustable). Stainless steel BS970 316 (1/2" BSP is standard). Other BSP, NPT and API are available on request. (suitable for pressures up to 3.5 bar)

Suitable for surface or panel mounting. (Pipe mounting and portable options available)

Standard Pressure Ranges

Pressure Range	Sensing Element	Material
0 to 30" Hg vacuum	Single Capsule	Beryllium Copper
-15 to +15 psi		
0 to 15 psi		
0 to 20 psi		
0 to 25 psi		
0 to 30 psi		
0 to 40 psi		
0 to 60 psi		
0 to 80 psi		
3 to 15 psi		
0 to 6 bar		
0 to 10 bar		
0 to 16 bar		
0 to 25 bar		
0 to 40 bar		
0 to 60 bar		
0 to 100 bar		
0 to 160	Bourdon Tube	Stainless Steel
0 to 250		
0 to 300		
0 to 400		
0 to 600		
0 to 1000		
0 to 1200		
0 to 1600		

Other ranges may be available - please contact Rototherm Sales

Standard Temperature Ranges

Temperature Ranges	
-40 to +40 Deg C	0 to 120 Deg C
-30 to +30 Deg C	0 to 160 Deg C
-30 to +50 Deg C	0 to 200 Deg C
-25 to +25 Deg C	0 to 300 Deg C
-25 to +30 Deg C	0 to 400 Deg C
0 to 40 Deg C	20 to 120 Deg C
0 to 50 Deg C	50 to 250 Deg C
0 to 60 Deg C	100 to 400 Deg C
0 to 100 Deg C	100 to 500 Deg C

other ranges may be available on request

RTO Recorder Bulb Types

Type 301

This bulb type is used when no compression fitting is required. This bulb may be held in place by a bracket or clip (not supplied by Rototherm) or may be inserted directly into the process.

Type 302

This bulb has a compression gland fitting that slides along the capillary and is tightened into the required position. This bulb type is only available with plain stainless steel capillary (type C1) - armoured capillaries are not available as it is not possible to move the fitting along the armoured capillary. Bulb length cannot be specified.

Type 303

Compression gland fittings tighten on the bulb to provide liquid and gas tight seal. Once fitted the position of the gland fitting can only be altered by cutting off the olive and replacing it with a new one.

If required this bulb type may be specified with a compression gland fitting - in this instance please confirm the required overall length of the bulb.

Type 301

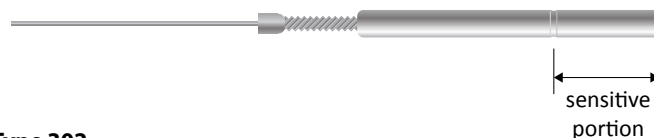

Type 302

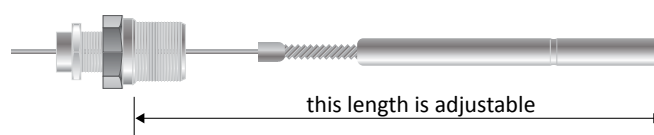

Type 303

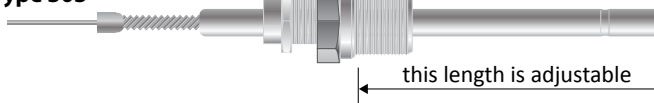

Dimensions

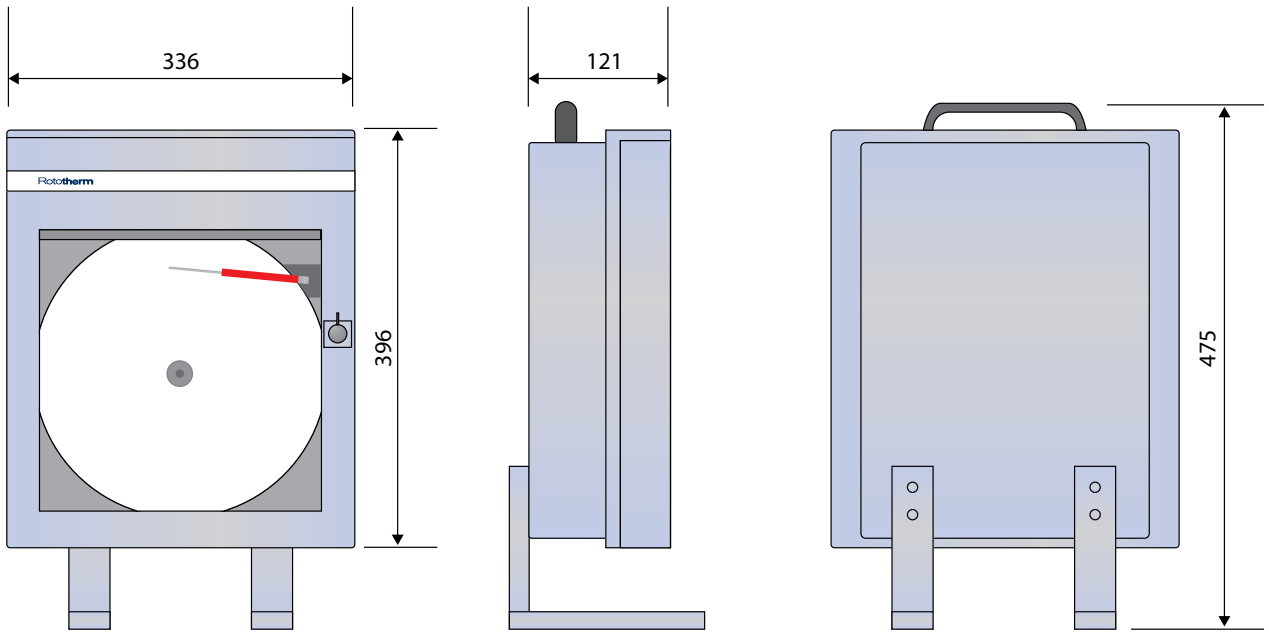

Portable Version

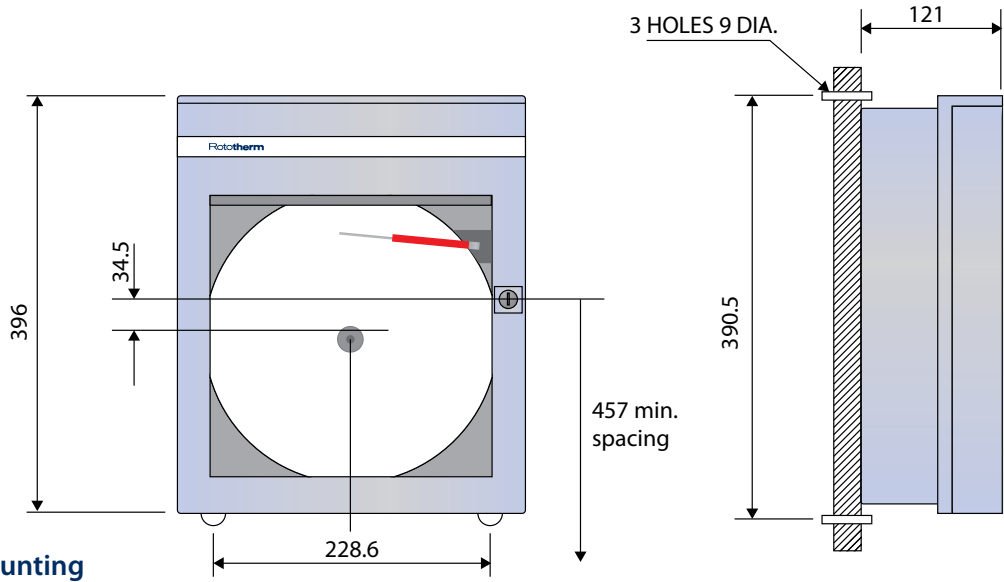

Surface Mounting

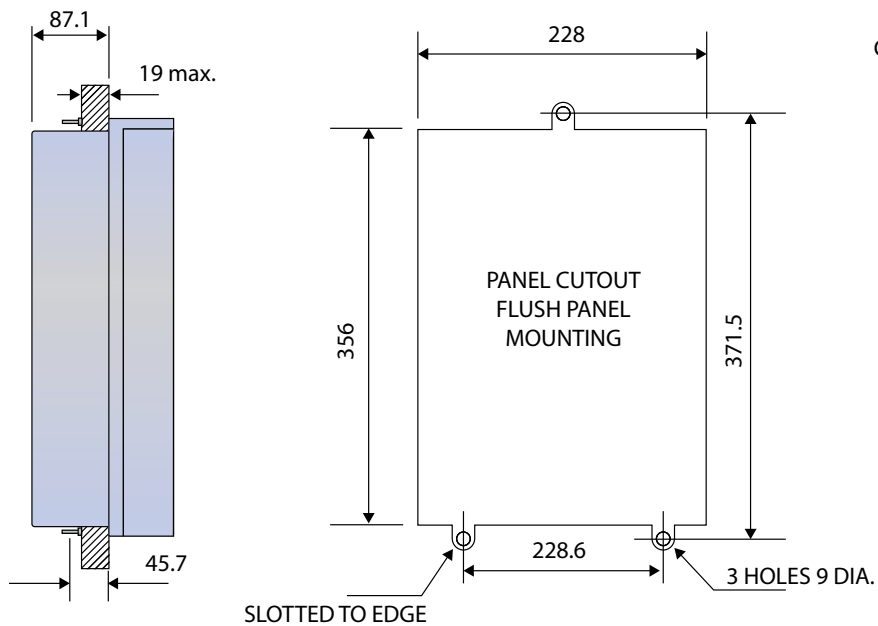

Panel Mounting

Ordering Codes - RPO Pressure Recorders

RPO Pressure Recorder, Single Pen

RPO Pressure Recorder, Two Pen

RPO Pressure Recorder, Three Pen

Code for 2nd pen (if required)

Code for 3rd pen (if required)

Mounting

Wall / Panel
Portable
2" Pipe/Post

Chart Drive

Electric 240V 50Hz
Electric 110V 50Hz
Mechanical Spring Wound
Battery Operated
Other*

Chart Rotation

24 hour
7 day
Other*

Process Connection

Standard (3/8" BSP male)
1/2" BSP male
Other

Element / Connection Material

Non ferrous - Beryllium Copper, Phosphor Bronze
Stainless steel
Other

Pressure Range

Enter range and unit of measurement

Notes:

- (a) Where Other* is specified please add note to order code stating exact requirements
- (b) When specifying different ranges for 2 or 3 pen recorders, care should be taken to use standard/compatible charts ranges.

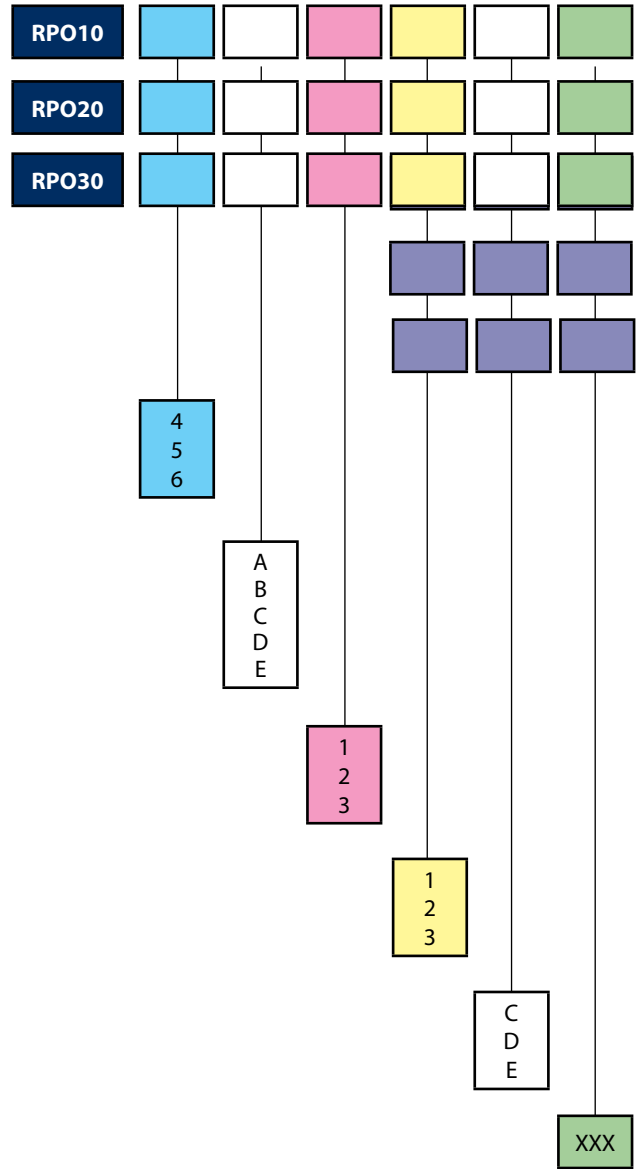

Example Order Code

Single pen pressure recorder, wall mounted, electrical 240 volt 50Hz chart drive, 24 hour rotation, standard stainless steel connection, stainless steel element, range 0 to 10 bar.

Ordering Codes - RTO Temperature Recorders

RTO Temperature Recorder, Single Pen



RTO Temperature Recorder, Two Pen



RTO Temperature Recorder, Three Pen



Code for 2nd pen (if required)

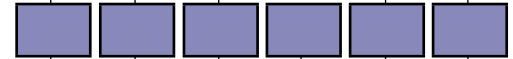

Code for 3rd pen (if required)

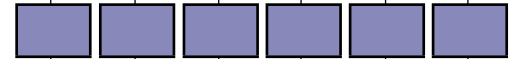

Mounting

Wall / Panel
Portable
2" Pipe / Post



Chart Drive

Electric 240V 50Hz
Electric 110V 50Hz
Mechanical Spring Wound
Battery Operated
Other*



Chart Rotation

24 hour
7 day
Other*



Bulb Options

Type 301
Type 302
Type 303

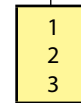

Capillary Type

Stainless steel
Flexible stainless armour
Flexible stainless armour over stainless

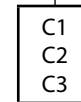

Capillary Length

3 metres
Other (enter length in metres)



Fitting / Gland (type 302 or 303 bulbs only)

No fitting required
1/2" BSP male
Other



Bulb Immersion Length (Type 303 bulbs only)

Enter length in mm



Temperature Range

Enter range in °C or °F



*Notes:

- When other is specified please add note to order code stating exact requirement.
- When specifying different ranges for 2 pen recorders, care should be taken to use compatible chart ranges. Details are available on request.

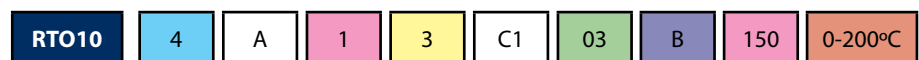

Example Order Code

Single pen temperature recorder, wall mounted, electrical 240 volt 50hz chart drive, 24 hour rotation, non-toxic Type 303 bulb, 3 metres of stainless steel capillary, immersion length 150 mm, 1/2" BSP male fitting, , range 0 to 200 Deg C.

Ordering Codes - Combined Temperature & Pressure Recorders

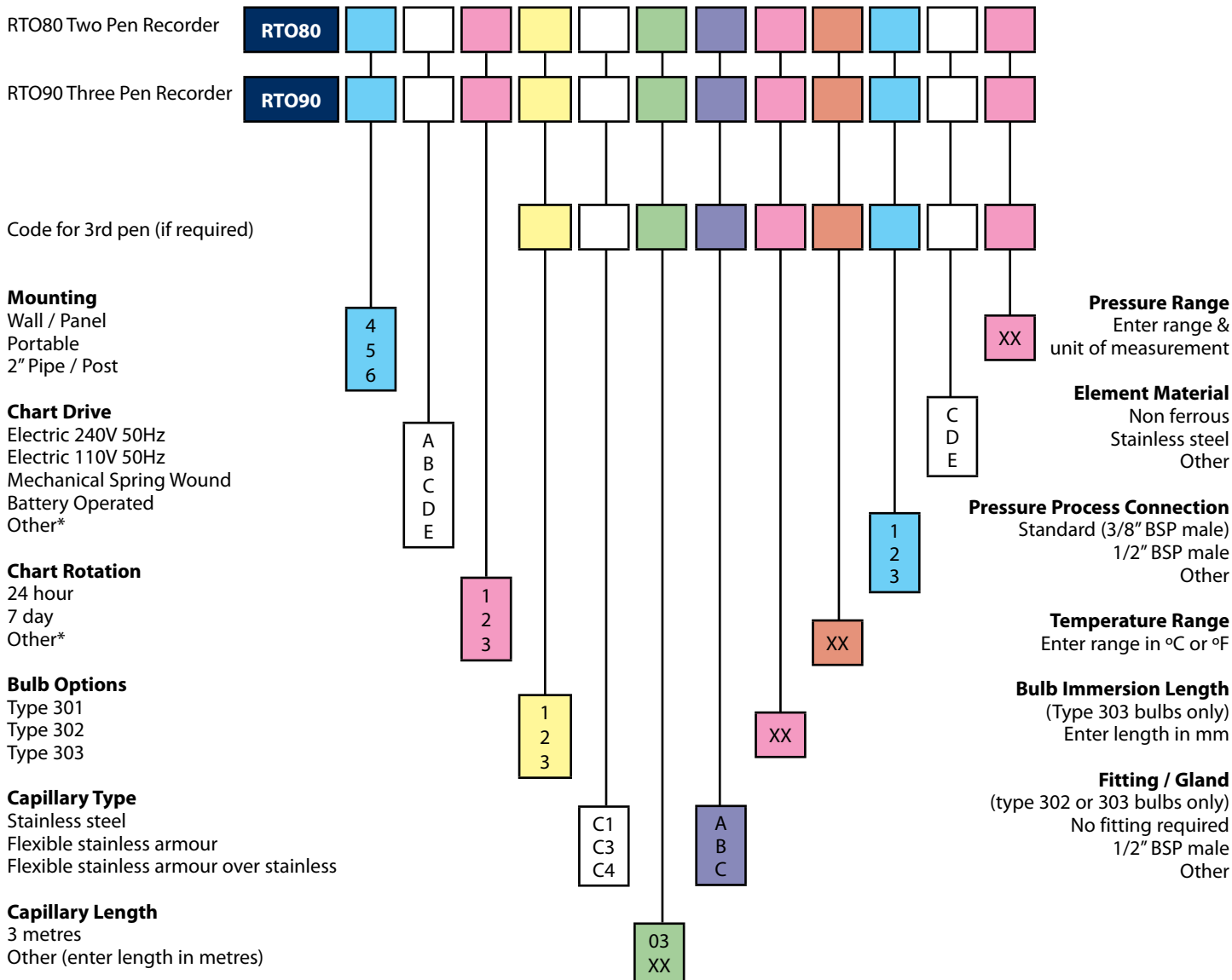

***Notes:**
 a) When other is specified please add note to order code stating exact requirement.
 b) When specifying different ranges for 2 pen recorders, care should be taken to use compatible chart ranges.
 Details are available on request.

RTO80 4 A 1 3 C1 03 B 150 0-200°C 2 D 0 to 200 BAR

Example Order Code

Two pen temperature & pressure recorder, wall mounted, electrical 240 volt 50hz chart drive, 24 hour rotation, type 303 bulb, 3 metres of stainless steel capillary, 1/2" BSP fitting, immersion length 150 mm, temperature range 0 to 200 Deg C, pressure range 0 to 200 bar, stainless steel pressure system. 1/2" BSP process connection



British Rotherm Company Limited

Kenfig Industrial Estate, Margam, Port Talbot SA13 2PW United Kingdom

T: +44 (0) 1656 740 551
 E: sales@rototherm.co.uk

F: +44 (0) 1656 745 915
 W: www.rotothermgroup.com